

Strainer Flange TYPE SZ03

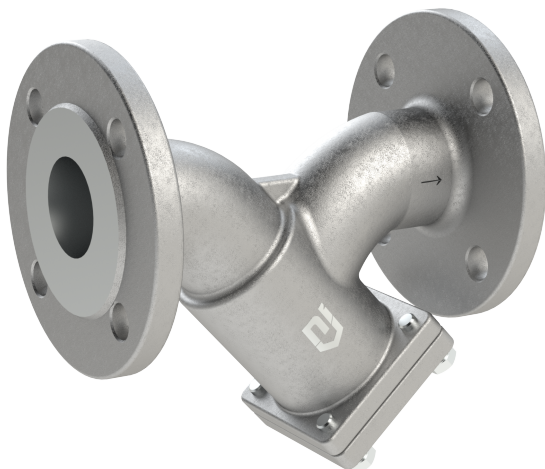

description:

Strainers are used to clean water.

features:

- Suitable for liquid media
- Removable stainless steel filter
- Bolted bonnet with draining cap
- Bolted bonnet with draining cap
- Removable stainless steel filter

connection:
DN15 – DN200

construction:
Y-design

pressure:
0 – 16 bar

design:	Y-strainer with draining cap
connection:	flange PN16 acc. to EN 1092-1
body:	stainless steel 1.4408
body gasket:	PTFE
filter:	stainless steel 1.4301
bonnet:	stainless steel 1.4408
bonnet gasket:	PTFE
draining cap:	stainless steel 1.4408
washer:	stainless steel 1.4301
screw:	stainless steel 1.4301
temperature:	-20°C - +200°C
pressure:	PN16

standards:

- Fabrication according to ISO 9001:2015
- Construction according to EN12516-1
- DIRECTIVE 2014/68/EU: CE N°0035 Risk category III Module H
- Pressure tests according to API 598 table 6
- Length according to EN 558 series 1 (DIN 3202 F1 – NF 29354)
- ATEX Zone 1 & 21 Zone 2 & 22

particularities:

- Respect the flow direction indicated by the arrow
- Horizontal or vertical position with descendant fluid
- Mesh 0,8 mm (800 μ) up to DN50, 1,0 mm at DN65 up to DN80, 3,0 mm from DN100



dimensions:

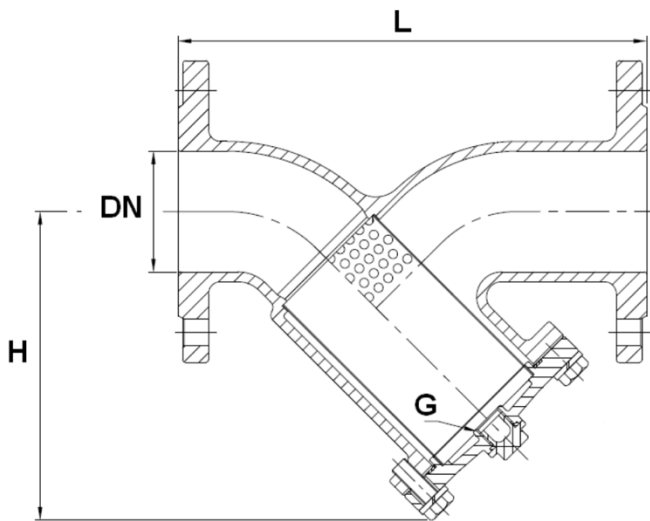

Filter size :

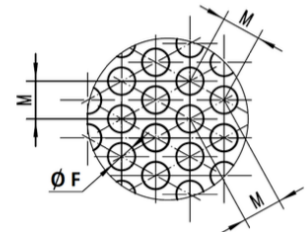
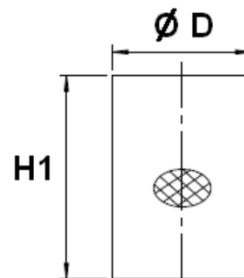

DN	L	H	G	Ø D	H1	Mesh	M	Kvs	Weight
15	mm	mm	Inch	mm	mm	mm	mm	m ³ /h	kg
15	130	85	1/2"	18	57	0,8	1,8	2,59	2
20	150	85	1/2"	23	55	0,8	1,8	6,05	2,7
25	160	112	1/2"	29	88	0,8	1,8	12,1	3,5
32	180	114	1/2"	40	82	0,8	1,8	17,3	5
40	200	132	1/2"	43	100	0,8	1,8	27,7	6,1
50	230	150	1/2"	54	103	0,8	1,8	56,2	8,1
65	290	185	1/2"	68	135	1	2	85,5	12,3
80	310	200	1/2"	84	150	1	2	138,4	15,5
100	350	232	3/4"	103	159	3	4	259,5	22
125	400	274	3/4"	130	220	3	4	415,1	30
150	480	328	3/4"	154	250	3	4	605,4	45,1
200	600	410	3/4"	208	300	3	4	882,3	77,1

flange dimensions PN16:

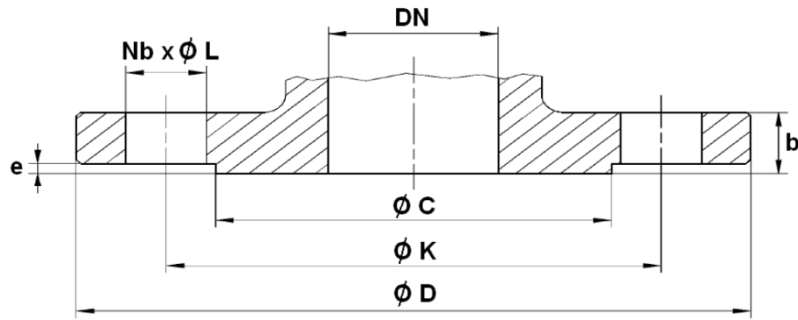

DN	Ø C	Ø D	Ø K	Nb x Ø L	b	e
	mm	mm	mm		mm	mm
15	45	95	65	4 x 14	14	2
20	58	105	75	4 x 14	16	2
25	68	115	85	4 x 14	16	2
32	78	140	100	4 x 18	16	2
40	88	150	110	4 x 18	16	3
50	102	165	125	4 x 18	18	3
65	122	185	145	4 x 18	18	3
80	138	200	160	8 x 18	20	3
100	158	220	180	8 x 18	20	3
125	188	250	210	8 x 18	22	3
150	212	285	240	8 x 22	22	3
200	268	340	295	12 x 22	24	3

pressure loss:

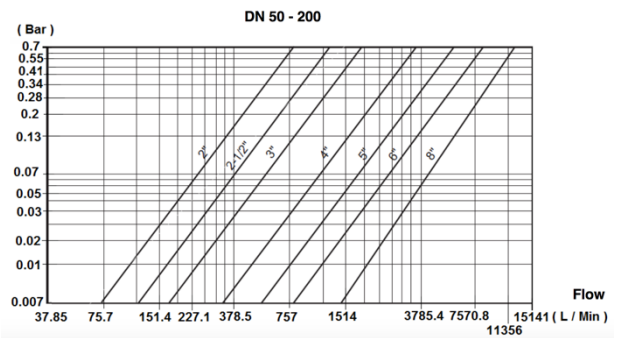
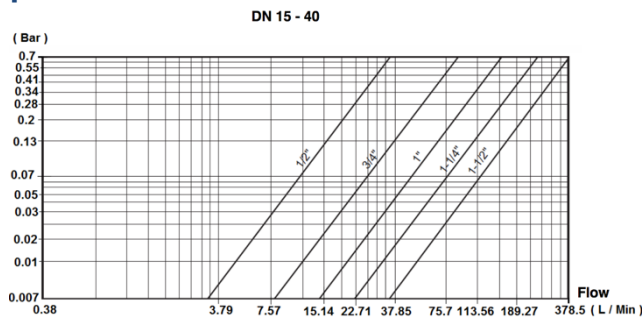

pressure / temperature:

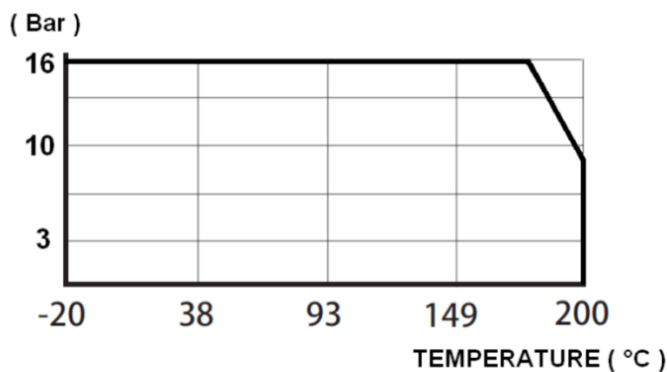

article number:

Type	Material	Pressure	Size
SZ03	00 – stainless steel	00 – PN16	03 – DN15 04 – DN20 05 – DN25 06 – DN32 07 – DN40 08 – DN50 09 – DN65 10 – DN80 11 – DN100 12 – DN125 13 – DN150 14 – DN200

Example no. SZ03000004:

SZ03	00	00	04
-------------	-----------	-----------	-----------

Strainer flange made of stainless steel

Pressure: PN16

Größe: DN20

Image similar, subject change without notice.